

M5 Display Monitor 2018 Version

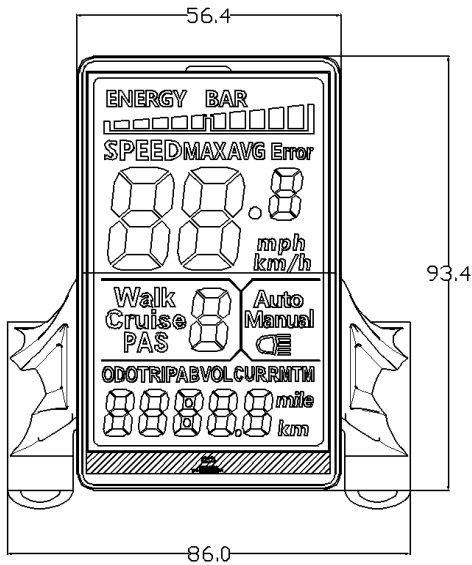

FRONT VIEW

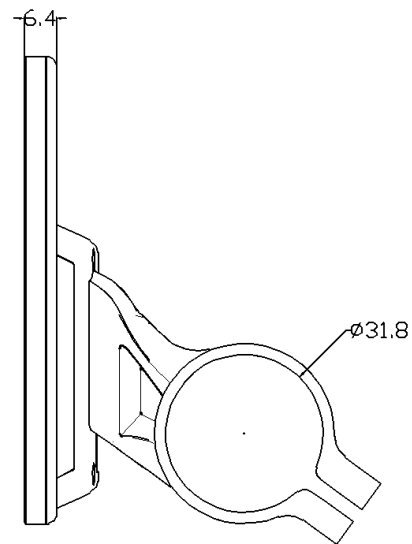

SIDE VIEW

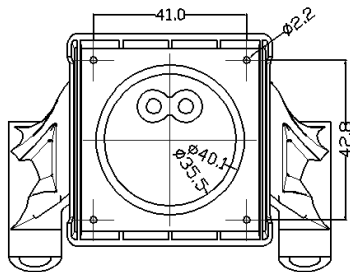

HOLDER

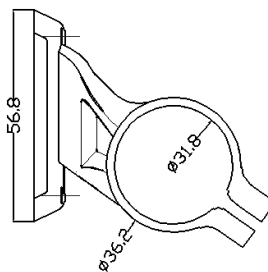

HOLDER



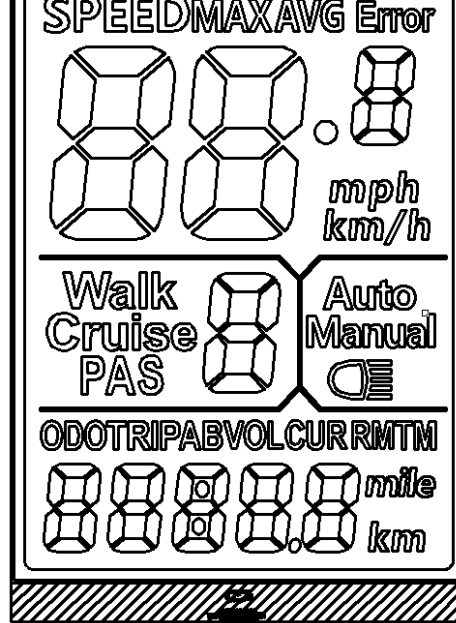

EXPLANATION:

3.1  HEAD LIGHT

3.2  ENERGY BAR
Battery Capacity left

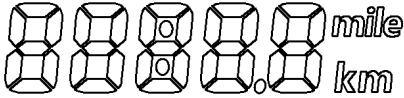
3.3  ODOTRIPABVOLCURRMTM
mile
km

ODO, single mileage TRIPA , TRIPB , current Voltage, current , mileage can go , trip time TM

3.4 PAS  PAS

PAS model (3 options , 5 options, 9 options)

3.5 WORKING MODE :  Walk Auto
Cruise Manual
Walk Cruise: 、 Auto: 、 Manual

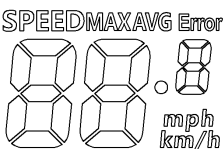
3.6 SPEED DISPLAY  SPEEDMAXAVG Error
mph
km/h
CURRENT SPEED、 MAX、 AVG、
mph or km/h

3.7  Error
Error CODE

CODE	DETAILS OF PROBLEM	REMARK
0	NORMAL	
1	NA	
2	BRAKING problem	

3	N A	
4	6KM/H cruise problem	
5	Cruise problem	
6	Low Voltage	
7	Motor problem	
8	Throttle problem	
9	Controller problem	
10	Communication problem	
11	Communication problem (delivering)	
12	BMS problem	
13	Head light problem	

3.8.Setting

P00: Return to factory default

P01: Background brightness , 1:less bright , 3: the brightest;

P02: 0: KM; 1: MILE;

P03: Voltage: 24V, 36V, 48V, Default :36V;

P04: Sleep : 0, no sleep; Range: 1-60; min;

P05: PAS : 3 Options 、 5 Options 、 9 Options ;

P06: Diameter of wheel: inch;

P07: Number of speed checking manage : 1-255;

P08: Speed Limit : 0-100 , 100 means in Max speed ,

P09: 0: Zero start ; 1: No Zero Start ;

P10: Driving Mode 0 : PAS only , no throttle function

1 : Throttle driving only ,no PAS

2 : Both PAS & Throttle

P11: PAS Sensitivity : 1-24;

P12: PAS starting Sensitivity : 0-5;

P13: SENSOR points : 5, 8, 12

P14: Current Limit of Controller , Default :12A Range: 1-20A

P15: Low Voltage setting

P16: ODO clearing, Hold up button for 5s

P17: NA

P17: NA

P18: NA

P19: NA



4、 Button combination :



Single button press & Combination Button Press :

1.  **S**peed or PAS option change

2.  Short time Press , display all data
Long time Press : MODE / ON (OFF) change

3.  +  Long time press to change speed display mode

4.

The ebike is in still , long time press  , enter 6KM/h cruise mode

5. Long time press  to open(off) the front light ;

6. In P16 , long time press  5s , ODO clearing .

7. Long time press  , Turn on (off) the monitor

8. Short time press  change multi function setting display

9. Long time press  +  Entering multi function setting : P01-P16

In the multi function setting , short time press  , or  to change the settings.

a. Long time press  to save the change

b. Short time press  to change to next setting , and save the current setting change ;

c. Press short time  +  , withdraw from setting ,save the change .

5

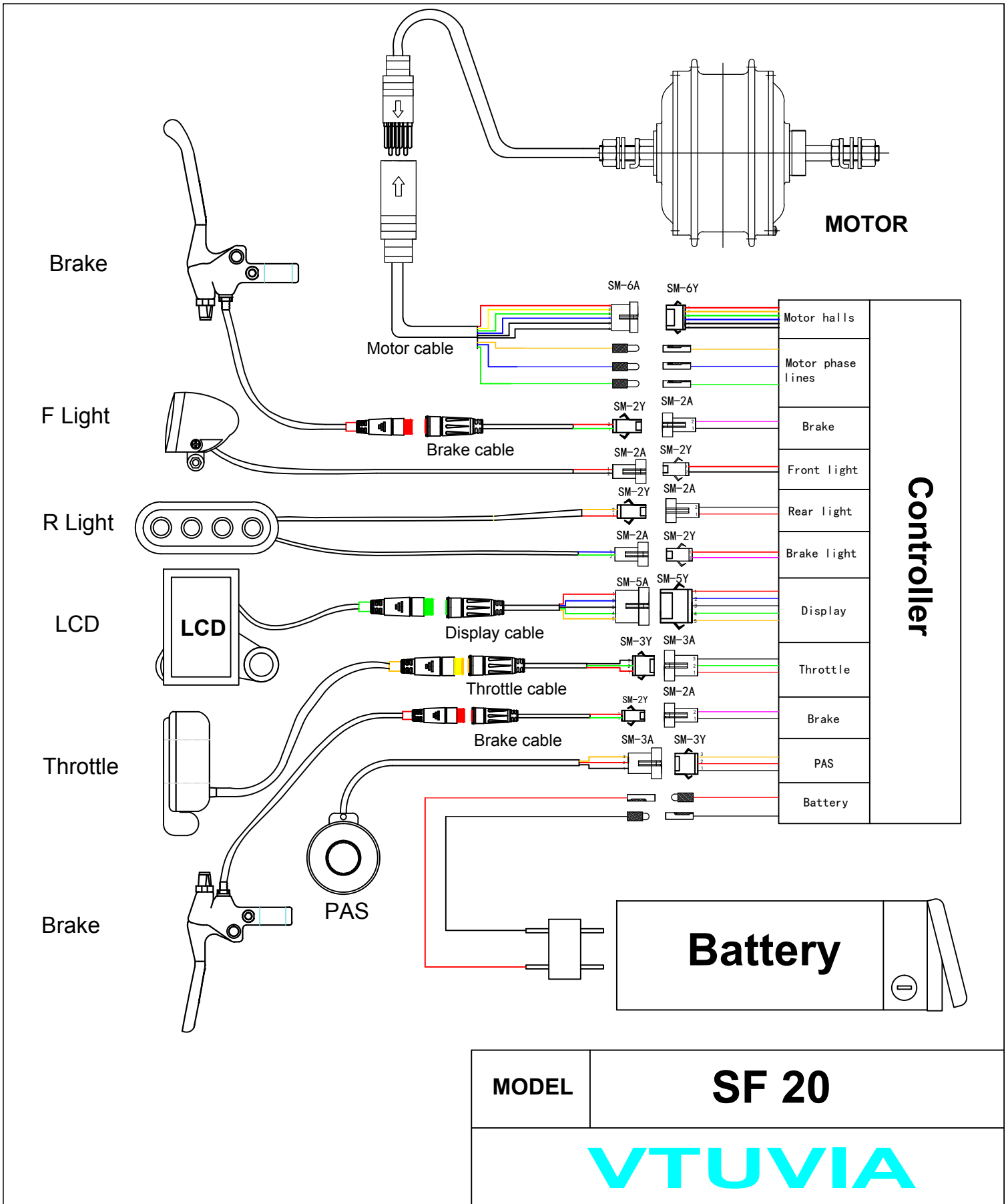

MODEL	SF 20
--------------	--------------

VTUVIA